

0909 Circulator (HP)

HR2101-S



3 Ports 2000 nm High Power Optical Fiber Circulator, SM, 10 W

The circulator has very low insertion loss, high return loss, high isolation and high stability & reliability. It can be used for fiber laser, fiber sensor and fiber instrument.

FEATURES

- High Return Loss
- Low Insertion Loss
- High Isolation
- High Stability & Reliability

USE IN

- Fiber Laser
- Fiber Sensor
- Fiber Instrument

MECHANICAL DRAWING

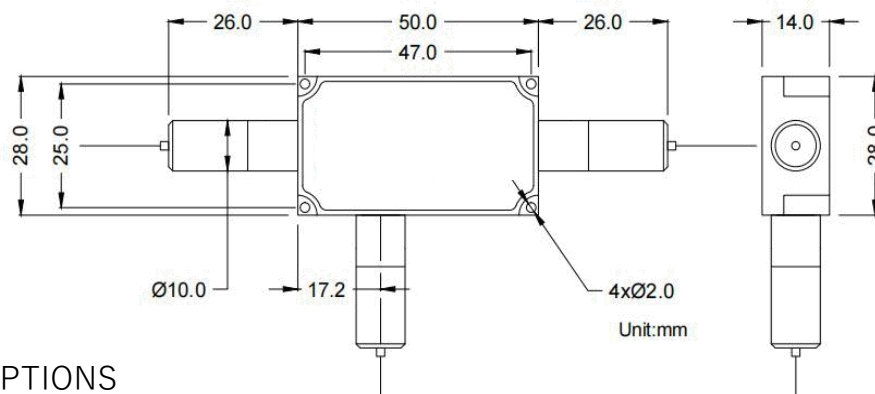

ORDERING OPTIONS

-XX: wavelength 1950 nm, 2050 nm

Port Type	3 Port
Center Wavelength	2000 nm
Operating Wavelength Range	±10 nm
Insertion Loss	1.3 dB max.
Isolation	16 dB min.
Crosstalk	50 dB min.
Polarization Dependent Loss	0.15 dB max.
Return Loss	50 dB min.
Power Handling	10 W max. or Specified
Dimension	50x28x14 mm
Tensile Load	5 N max.
Operating Temperature	0°C to +70°C
Storage Temperature	-40°C to +85°C

* With connectors, the handling power is 1 W only, IL is 0.3 dB higher, RL is 5 dB lower, and ER is 2 dB lower.

Order notes to our customers: The default parameters are as follows. For special needs, please contact sales.

1) Connector FC/APC, 900 um, 1 m by default for all devices except for high power devices.

2) Slow axis working, fast axis blocked, connector key is aligned to slow axis by default for PM devices.