

0909 Circulator (HP)

HR1100-S



3 Ports 850 nm High Power Optical Fiber Circulator, SM, 5 W

The circulator has very low insertion loss, high return loss and high stability & reliability. It can be used for fiber laser, testing instrument and medical equipment.

FEATURES

- High Return Loss
- Low Insertion Loss
- High Stability & Reliability

USE IN

- Fiber Laser
- Testing Instrument
- Medical Equipment

MECHANICAL DRAWING

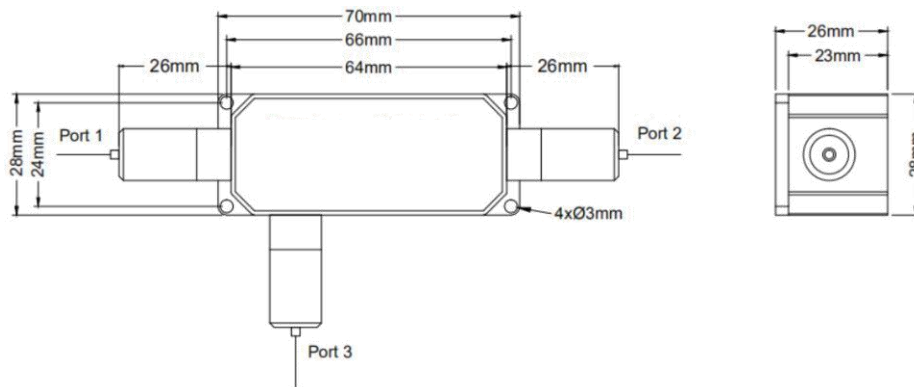

Center Wavelength	850 nm
Operating Wavelength Range	±5 nm
Isolation	23 dB typ.@ Peak; 20 dB min.
Insertion Loss	1.2 dB typ.; 1.5 dB max.
Polarization Dependent Loss	0.15 dB max.
Return Loss (In/Out)	45 dB min.
Cross Talk	45 dB min.
Power Handling (Including Port1 & Port2)	5 W max. or Specified
Peak Power for ns Pulse	10 kW max. or Specified
Tensile Load	5 N max.
Dimension	70x28x26 mm
Operating Temperature	+10°C to +50°C
Storage Temperature	0°C to +60°C

* With connectors, the handling power is 1 W only, IL is 0.3 dB higher, RL is 5 dB lower, and ER is 2 dB lower.

Order notes to our customers: The default parameters are as follows. For special needs, please contact sales.

1) Connector FC/APC, 900 um, 1 m by default for all devices except for high power devices.

2) Slow axis working, fast axis blocked, connector key is aligned to slow axis by default for PM devices.