

0906 Other High Power Device

HH1101-S



850 nm High Power Tap Isolator Hybrid, 1/99, 10 W, SM

The isolator has very low insertion loss, high return loss, high isolation and high extinction ratio. It can be used for fiber sensor, fiber laser and compact fiber optical system.

FEATURES

- High Return Loss
- Low Insertion Loss
- High Extinction Ratio
- High Isolation

USE IN

- Fiber Sensor
- Fiber Laser
- Compact Fiber Optical System

MECHANICAL DRAWING

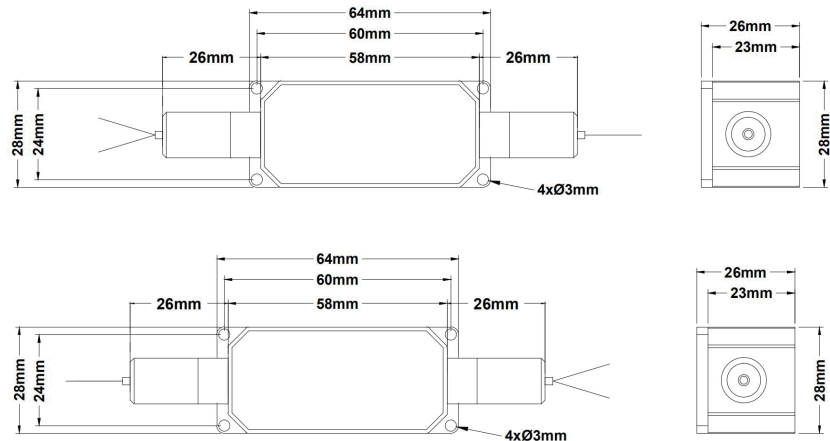

Options for Working Axis

Option 1, 2x1

Input→Output: Fast axis blocked
Input→Tap: Both axis working

Option 2, 2x1

Input→Output: Both axis working
Input→Tap: Both axis working

Option 3, 2x1

Input→Output: Both axis working
Input→Tap: PM to SM, Polarization Insensitive

Option 4, 2x1

Input→Output: SM to SM, Polarization Insensitive
Input→Tap: SM to SM, Polarization Insensitive

Option 5, 1x2

Input→Output: Fast axis blocked
Input→Tap: Fast axis blocked

Option 6, 1x2

Input→Output: Fast axis blocked
Input→Tap: PM to SM, Polarization Sensitive

Option 7, 1x2

Input→Output: SM to SM, Polarization Sensitive
Input→Tap: SM to SM, Polarization Sensitive

Center Wavelength	850 nm
Operating Wavelength Range	±5 nm
Excess Loss	1.0 dB max.
Signal Tap Ratio	1±0.2% or Specified
Isolation	25 dB min.
Polarization Dependent Loss	0.15 dB max.
Return Loss	50 dB min.
Power Handling	10 W max. or Specified
Peak Power for ns Pulse	10 kW or Specified
Tensile Load	5 N max.
Operating Temperature	+10°C to +50°C
Storage Temperature	0°C to +60°C

* With connectors, IL is 0.3 dB higher, RL is 5 dB lower, and ER is 2 dB lower.

Order notes to our customers: The default parameters are as follows. For special needs, please contact sales.

1) Connector FC/APC, 900 um, 1 m by default for all devices except for high power devices.

2) Slow axis working, fast axis blocked, connector key is aligned to slow axis by default for PM devices.