



IMP-1550-6-PM



DEVICE

1550 nm, 6 GHz Intensity Modulator w/PM Output

The Optilab IMP-1550-6-PM is a 6 GHz Intensity Modulator that is manufactured with Annealed Proton Exchange(APE) process, it features a zero-chirp design and Polarization Maintaining(PM) fiber output. IMP-1550-6-PM features 6 GHz E/O bandwidth, a highly linear transfer function and excellent extinction ratio. Applications include digital transmission up to 6 GHz, optical pulse generation, mode-locked fiber laser and microwave optical link. The IMP-1550-6-PM is compatible with a wide variety of modulator drivers, and a separate bias port allows the modulator to operate at specific points of the transfer function.

The IMP-1550-6-PM Modulator is designed for external modulation of 1550 nm laser up to 6 GHz. It is also applicable for pulse generation for Master Oscillator Power Amplifier(MOPA) configuration. Due to proprietary APE technology, IMP-1550-6-PM can handle up to 100mW input optical power. It has a wide operating temperature tolerance ranging from -30°C to +70°C. Contact Optilab for more information.

OVERVIEW

FEATURES

- PM fiber output
- High input power
- Zero chirp design
- Internal PD option
- 1520 -1580 nm operating wavelength
- High Extinction Ratio (HER) Available
- Temperature range of -30°C to 70°C

USE IN

- RF over fiber
- Pulse generation
- MOPA
- Analog modulation up to 6 GHz
- Active mode locked laser
- Satellite Link

FUNCTIONAL DIAGRAM

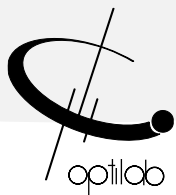
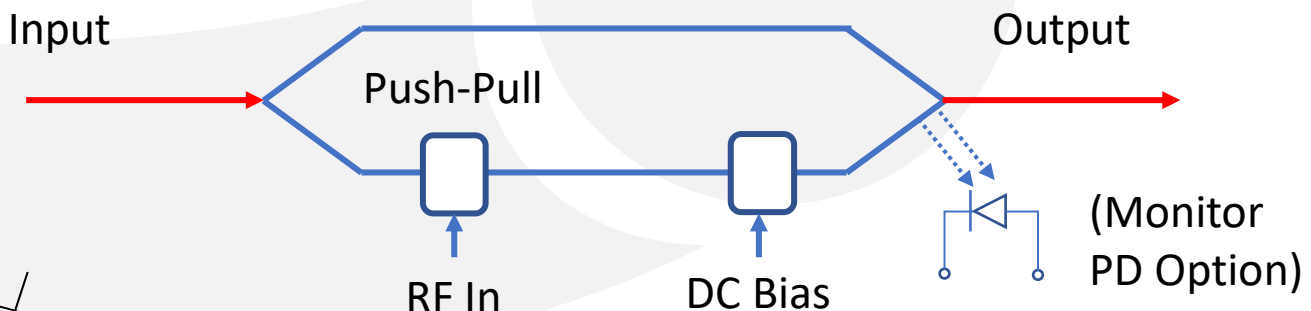



IMP-1550-6-PM

SPECIFICATIONS

Maximum Input Power	100 mW
Operating Wavelength	1550 ± 30 nm
Chirp Value	≤ 0.2
Insertion Loss	4.5 dB typ., 5.0 dB max.
Extinction Ratio	≥ 20 dB standard. ≥ 30 dB HER version
Optical Return Loss	≤ -45 dB
S21 3 dB Bandwidth	5 GHz min., 6 GHz typ.
Polarization Extinction Ratio	17 dB min., 20 dB typ.
S11 Return Loss	≤ -7 dB up to 10 GHz
RF V π (@ 1 GHz)	6 V typ., 7 V max.
RF Input Power	26 dBm max.
Impedance (RF Port)	50 Ω typ.
Bias V π (@ 1 kHz)	6.8V typ., 7.5V max.
Impedance (Bias Port)	1 M Ω min.
Internal PD Responsivity	> 10 mA/W

GENERAL

Operating Temperature	-30 °C to +70 °C
Storage Temperature	-50 °C to +80 °C
Operating Humidity	0% to 90% Relative Humidity
Input/Output Fiber Type	Panda PM15-U400, 400um buffer
Input Connector	PM FC/APC, slow axis aligned to Key
Output Connector	PM FC/APC, slow axis aligned to Key
Crystal Orientation	X-cut, Y-propagating
Waveguide Process	Annealed Proton Exchange (APE)
RF Port Connector	SMF Female
Cabling	900 um loose tubing
Dimensions	96 mm x 14 mm x 8.5 mm

MECHANICAL





IMP-1550-6-PM

MECHANICAL DRAWING

1. IMP-1550-6-PM-PD Housing, w/Monitor PD

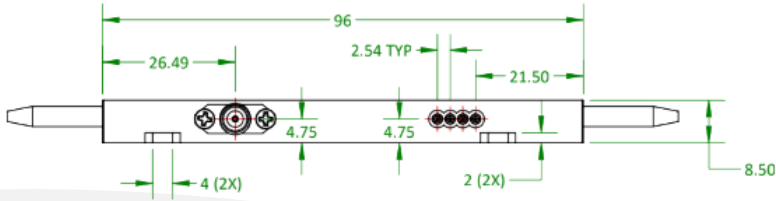
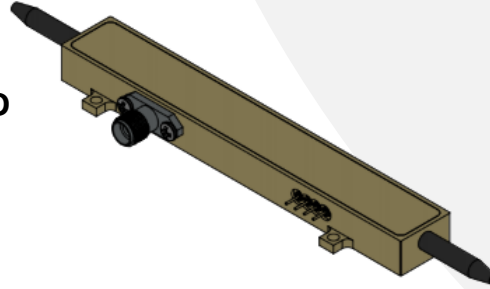

FRONT VIEW

Unit: mm

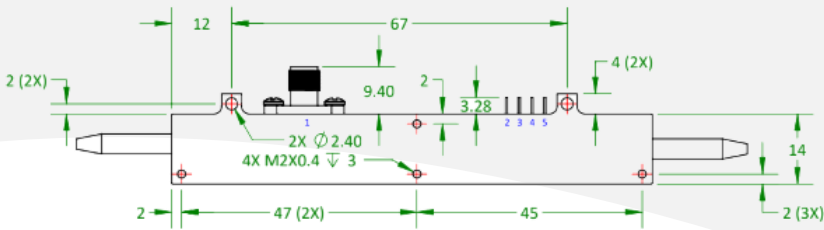

BOTTOM VIEW

PIN #	Description
1	RF Input
2	GND
3	Bias
4	PD-Anode
5	PD-Cathode

2. IMP-1550-6-PM Housing, No Monitor PD

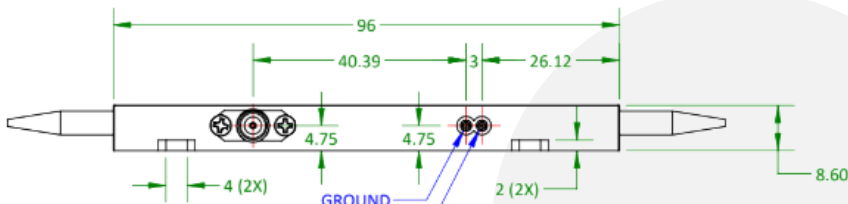
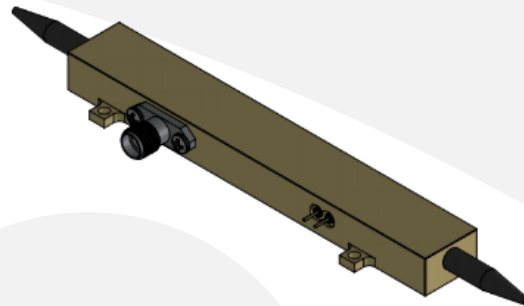

FRONT VIEW

Unit: mm

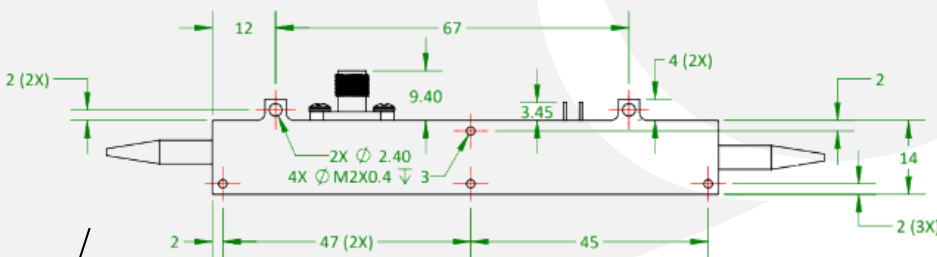

BOTTOM VIEW

PIN #	Symbol
G	GND
B	BIAS





IMP-1550-6-PM

ORDERING
OPTIONS

IMP-1550-6-PM-XX
XX PD: Monitor PD Option

Available
Automatic
Bias Controller

- **BCB-4**



The Optilab BCB-4 is a compact automatic bias controller designed for biasing MZI Intensity modulator

Available
Laser Source

- **DFB Laser Source**



The Optilab DFB-1550-PM-50 laser has polarization maintaining high output power up to 50mW

